

### USB

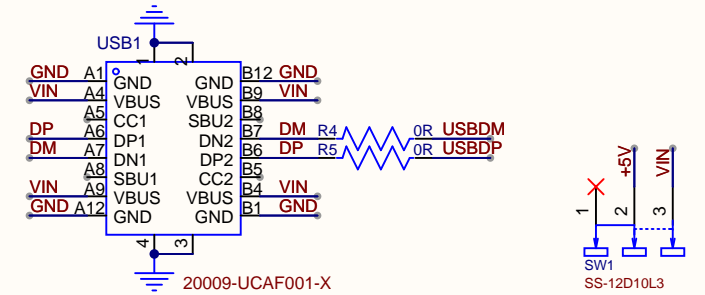

### 5V To 3V3

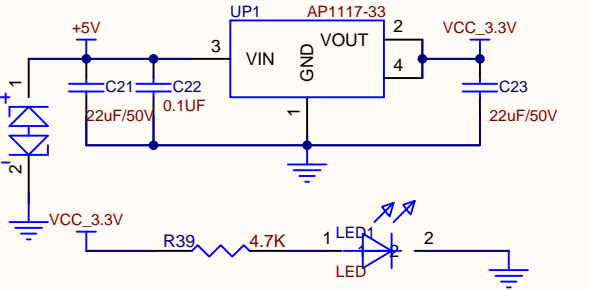

### SD-CARD

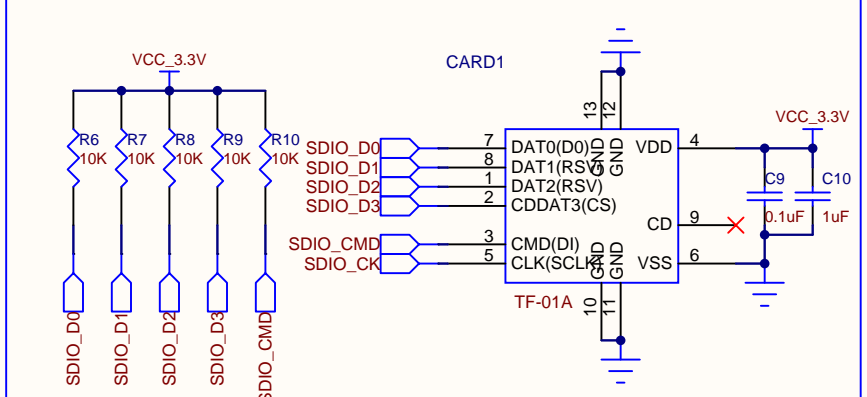

### JTAG&SWD

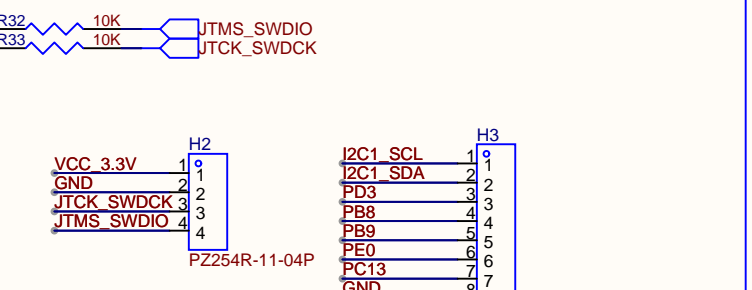

### 7 Inch VGH,VHL

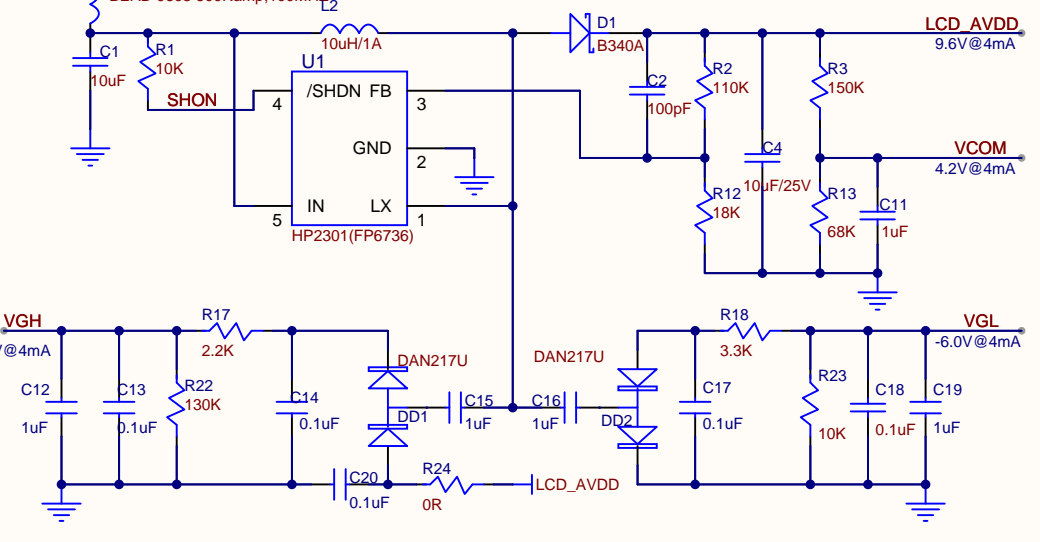

### LCD-Backlight

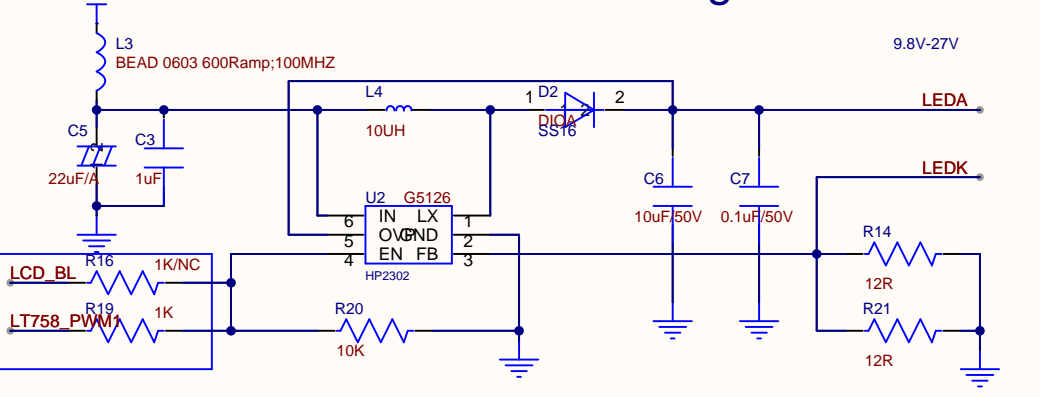

### CTP

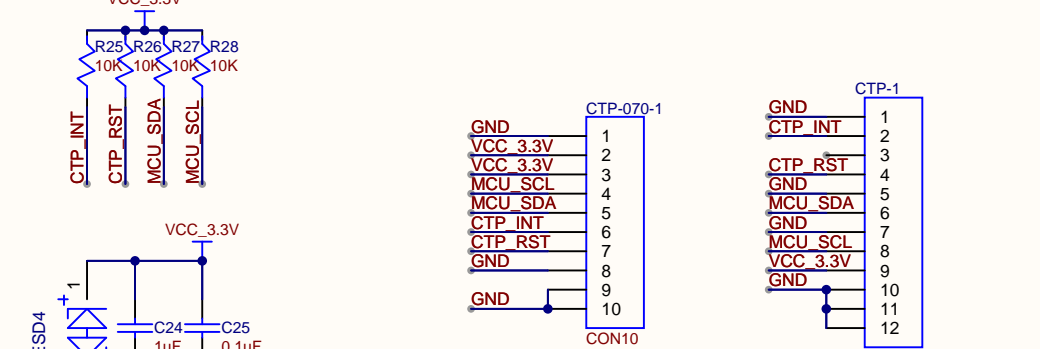

### 5 Inch

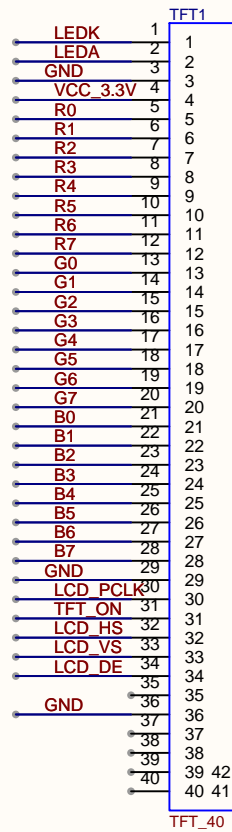

### 7 Inch

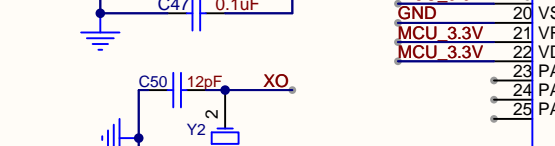
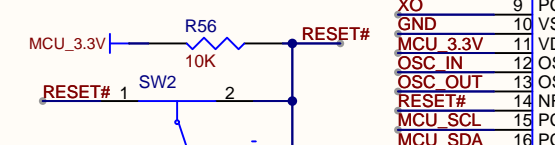
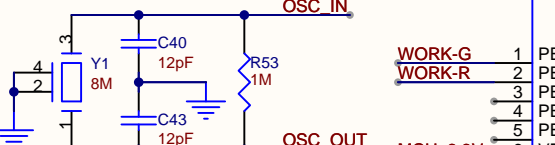
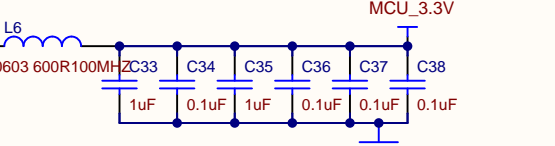
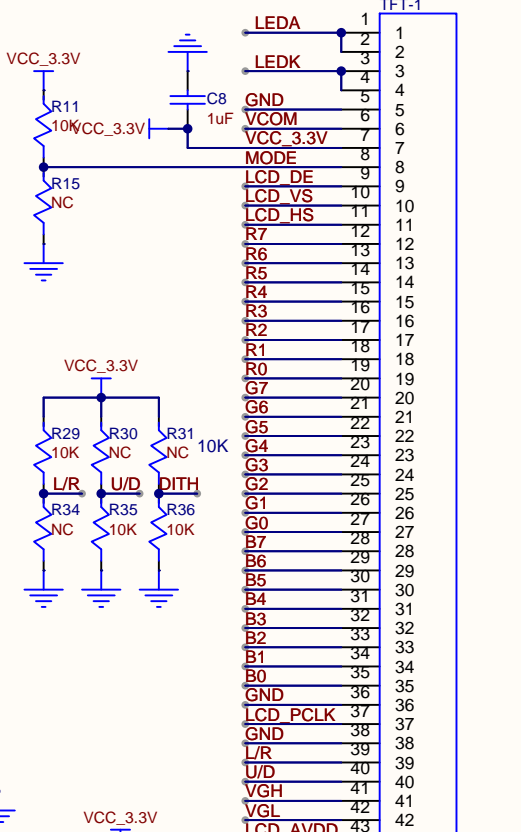

### FLASH

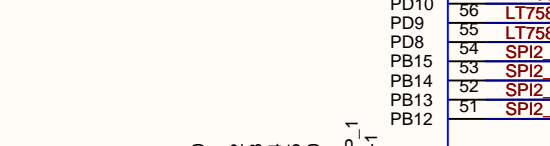
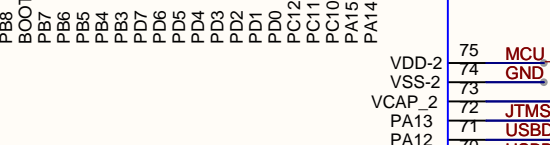
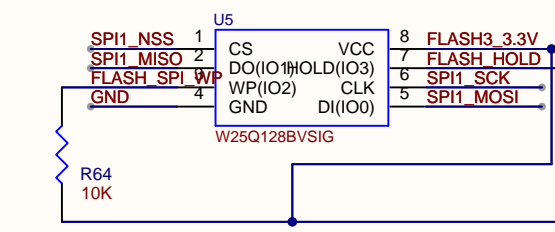

### FLASH

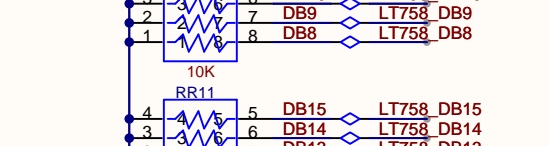
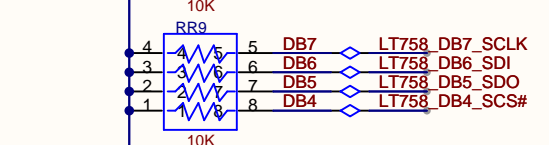
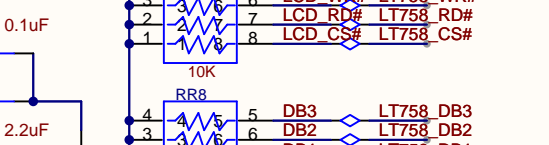
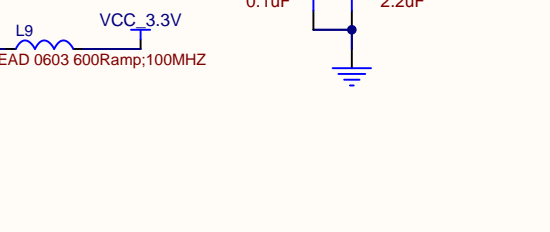

### FLASH

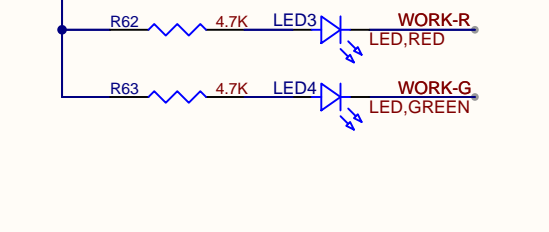

### LT7583

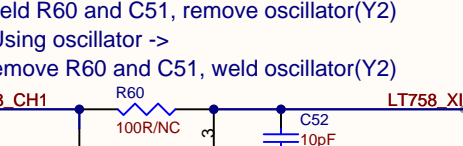
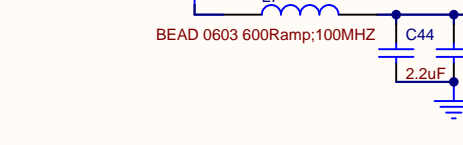
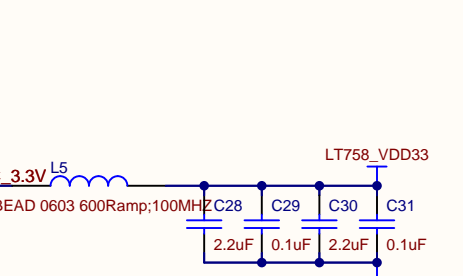

### FLASH

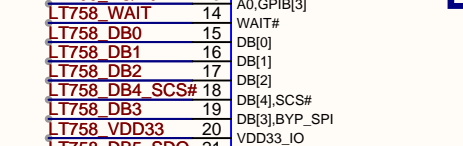
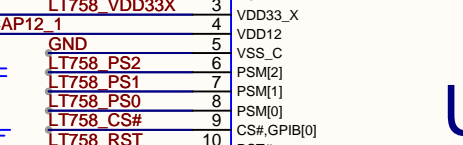
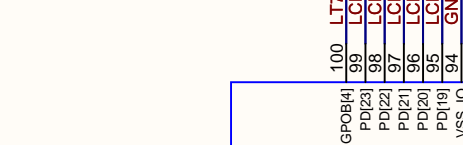
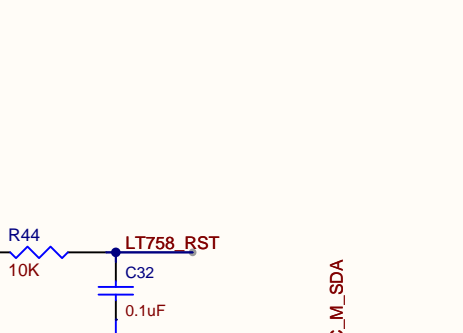
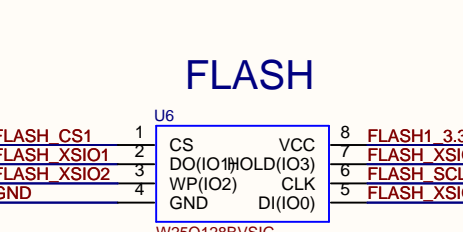

### FLASH

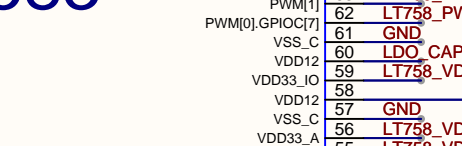
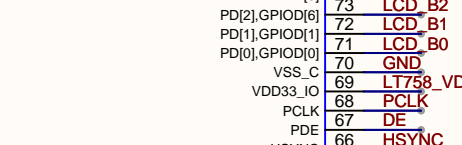
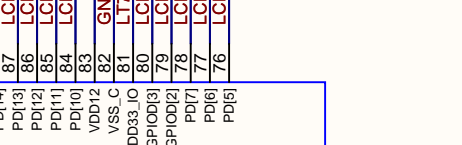
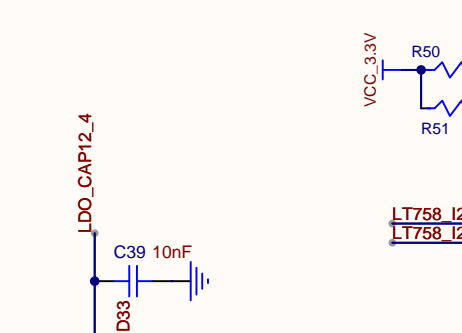
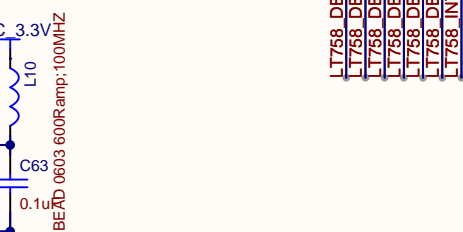

### FLASH

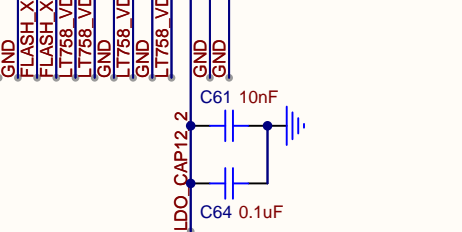

Schematic	LT7583_STM_MAIN_V1.0	Update Date	2024-10-14
Page	LT7583_STM_MAIN_V1.0	Create Date	
Drawn		Part Number	
Reviewed			
	VER	SIZE	PAGE 1 OF 1
	V2.0		Levetop Semiconductor.

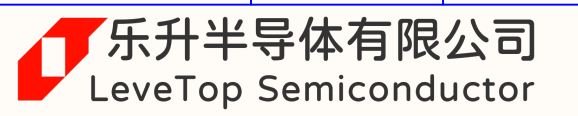

乐升半导体有限公司  
LeveTop Semiconductor